

Block diagram

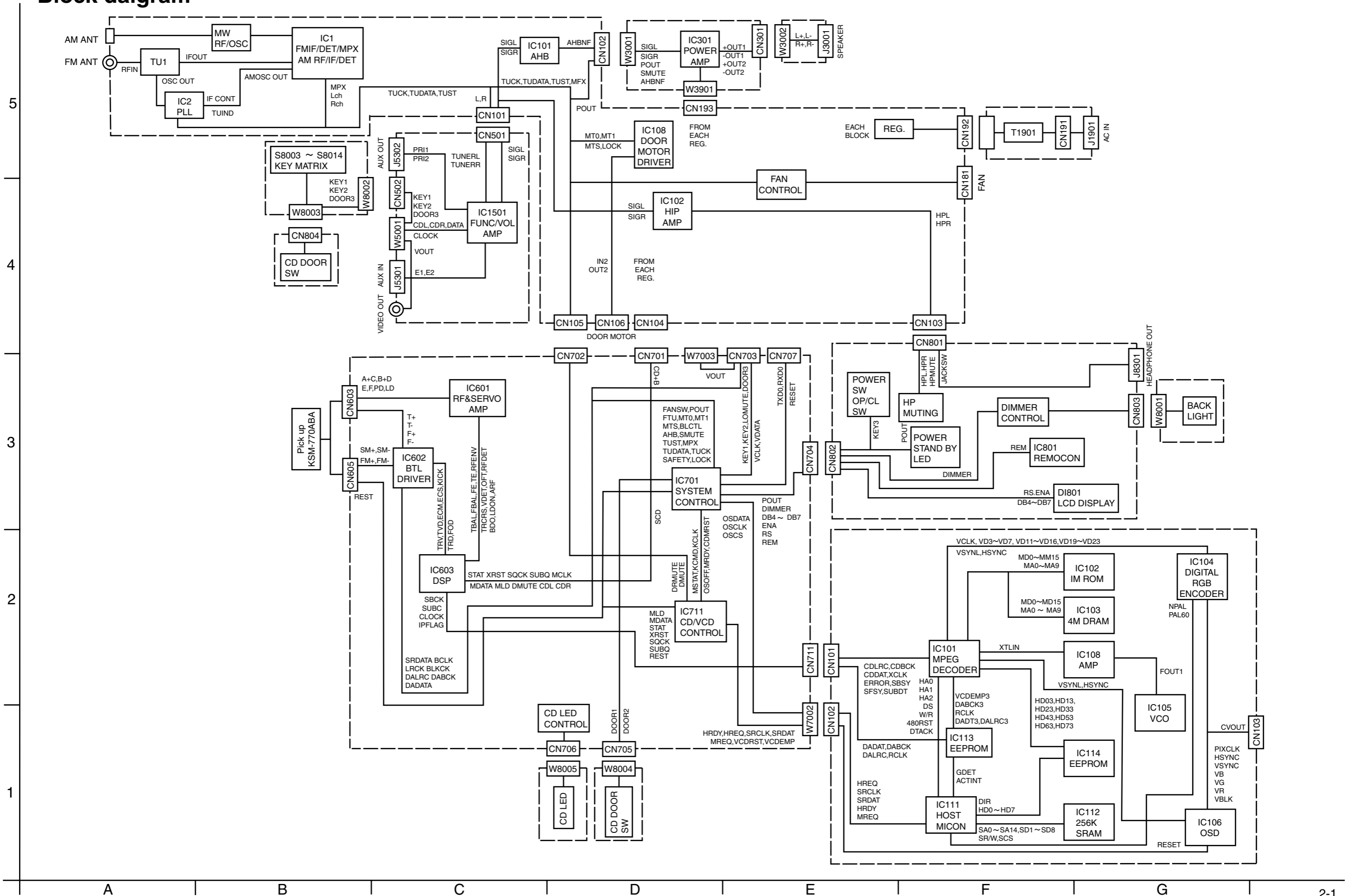

Standard schematic diagrams

■ CD servo control section

FS-SD58V/FS-SD78V/FS-SD98V

FS-SD58V/FS-SD78V/FS-SD98V

5

4

3

2

1

KSM-770ABA

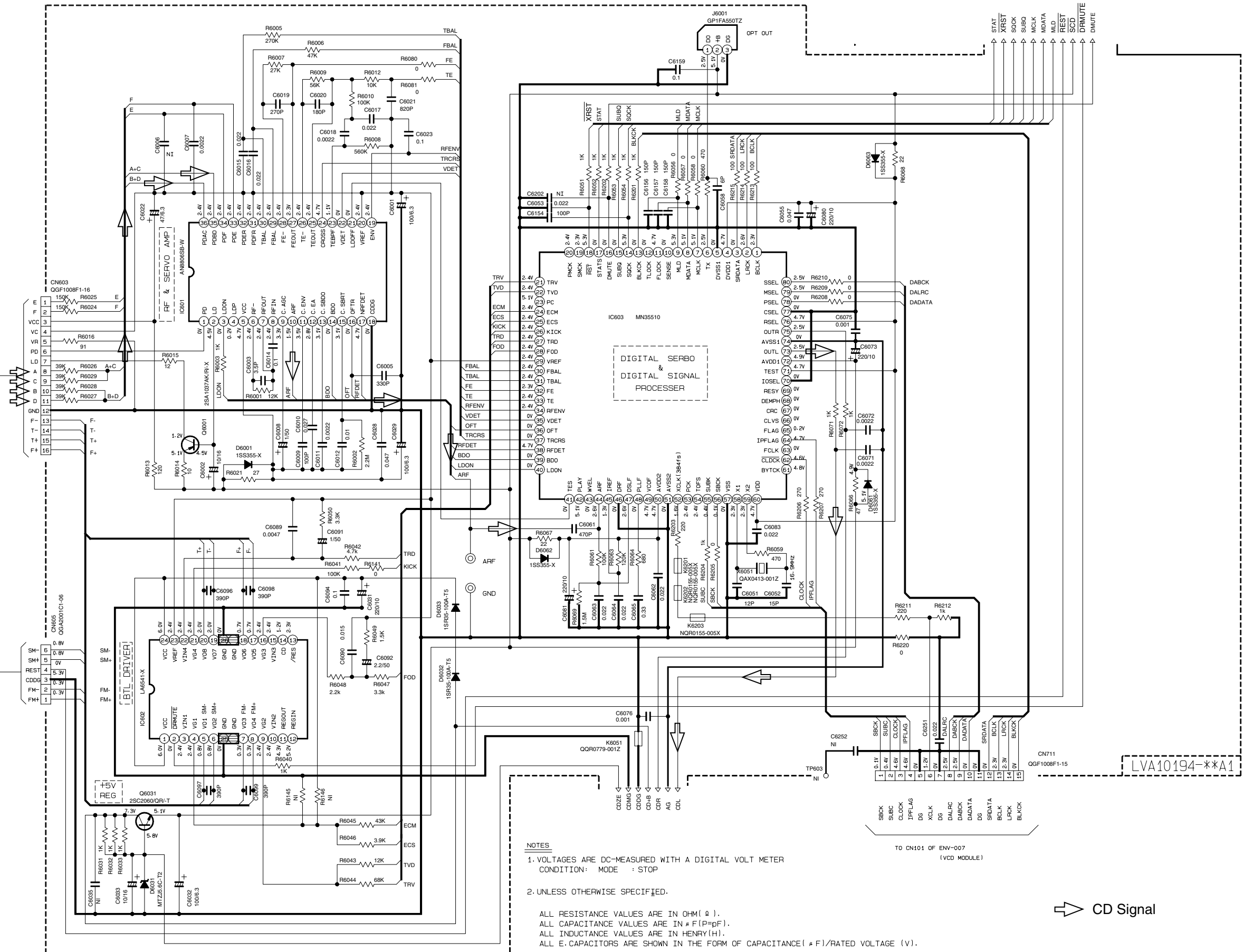

NOTES

1. VOLTAGES ARE DC-MEASURED WITH A DIGITAL VOLT METER
CONDITION: MODE : STOP
2. UNLESS OTHERWISE SPECIFIED.

ALL RESISTANCE VALUES ARE IN OHM (Ω).
ALL CAPACITANCE VALUES ARE IN μF (P=PF).
ALL INDUCTANCE VALUES ARE IN HENRY (H).
ALL E. CAPACITORS ARE SHOWN IN THE FORM OF CAPACITANCE (μF)/RATED VOLTAGE (V).

➔ CD Signal

Power supply & main circuit section

5

4

3

2

1

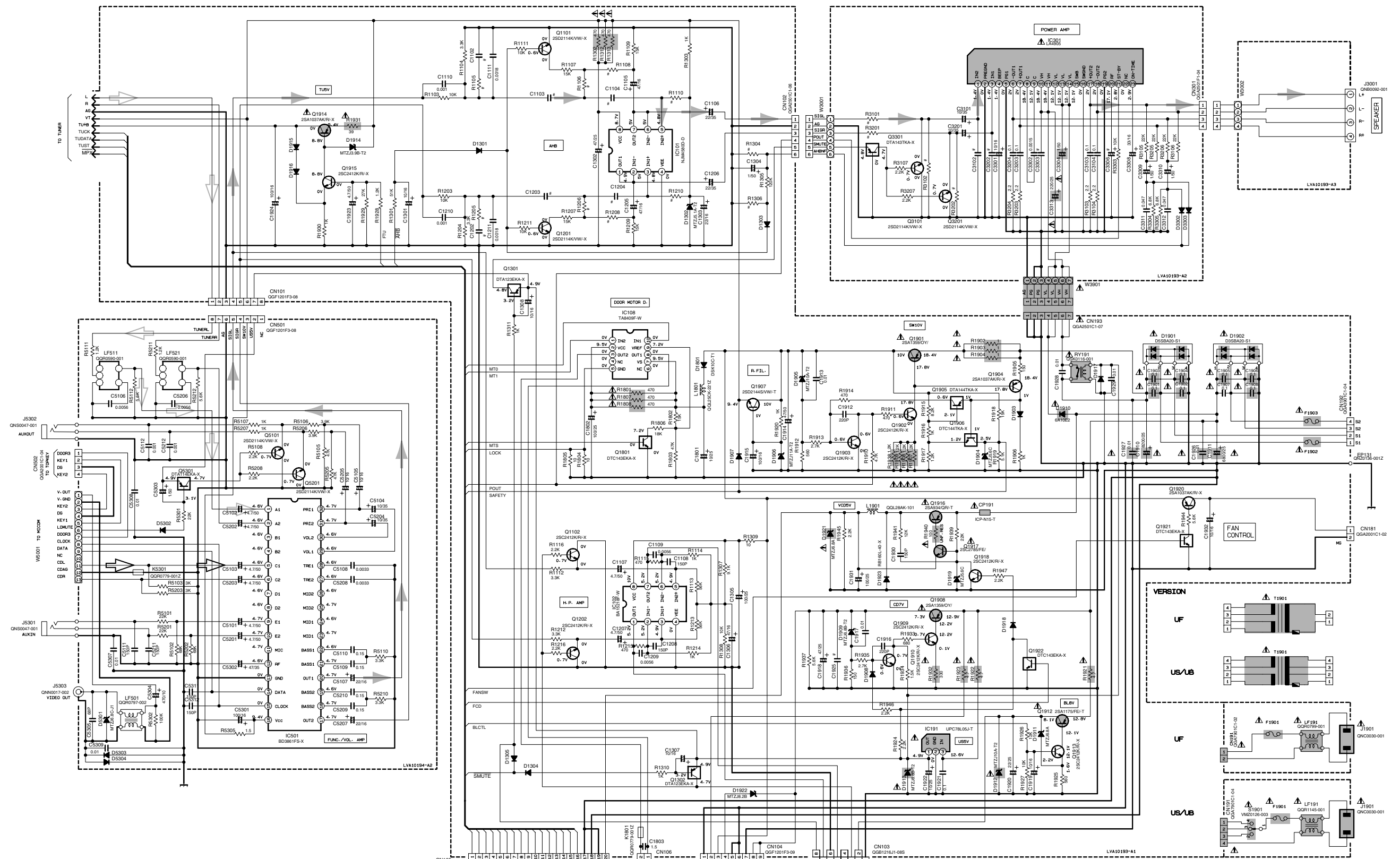

- NOTES
1. VOLTAGES ARE DC-MEASURED WITH A DIGITAL VOLT METER OR OSCILLOSCOPE WITHOUT INPUT SIGNAL. CONDITION — CD STOP MODE
 2. UNLESS OTHERWISE SPECIFIED, RESISTORS ARE ± 5% CARBON RESISTOR. ALL RESISTANCE VALUES ARE IN OHM(Ω). ALL CAPACITANCE VALUES ARE IN PICO(F). ALL CAPACITORS ARE CERAMIC CAPACITOR OR MYLAR CAPACITOR. ALL INDUCTANCE VALUES ARE IN HENRY(H). ALL CAPACITORS ARE SHOWN IN THE FORM OF CAPACITANCE (μF)/RATED VOLTAGE (V). ALL DIODES ARE 1SS133.

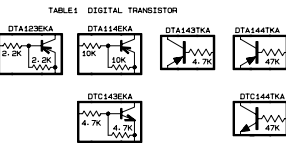

#Marks

	R1800	C1102	C1103	C1104	R1105	R1106	R1107	R1108	R1109	R1110	R1304	R1306	R3101	R3102	C3103	C3303	C3306	C1505
96V	3.9K	0.15	0.082	0.082	1.5K	3K	180K	150K	51K	5.6K	6.8K	820P	0.01	100/75	0.01			
78V	2.7K	0.22	0.056	0.056	3.9K	4.3K	220K	220K	56K	5.6K	10K	680P						
96V																0.1	47/25	0.022

	T1901	F1901	F1902	F1903
US/UB	02T0289-004	02F51E2-190-J1	02F51E2-190-J1	02F51E2-3R15-J1
UF	02T0289-006	02F51E2-190-J1	02F51E2-6R3-J1	02F51E2-3R15-J1

- Tuner signal
- CD signal
- Main signal
- Parts are safety assurance parts. When replacing those parts make sure to use the specified one.

■ System control section

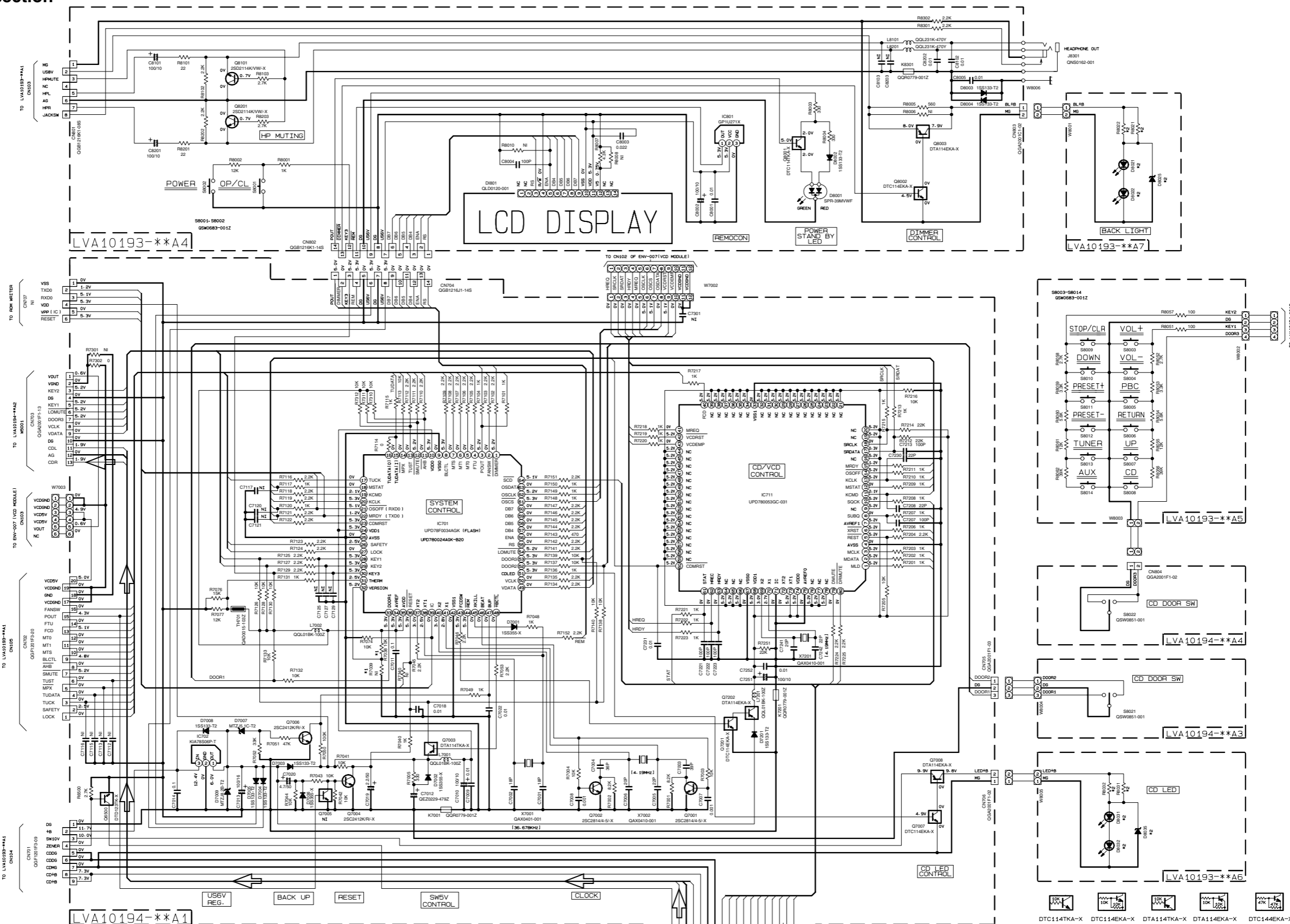

- VOLTAGES ARE DC-MEASURED WITH A DIGITAL VOLT METER OR OSCILLOSCOPE WITHOUT INPUT SIGNAL.
CONDITION — CD STOP AT AC SUPPLY
VOL: 15 BASS/O THERLE/O AHB/ON DIMMER/OFF
- UNLESS OTHERWISE SPECIFIED, RESISTORS ARE 1/10W ±5% MG RESISTOR, OR 1/16W.
ALL RESISTANCE VALUES ARE IN OHM(Ω).
ALL CAPACITORS ARE CERAMIC CAPACITOR OR MYLAR CAPACITOR.
ALL CAPACITANCE VALUES ARE IN P(F)=PF.
ALL CAPACITANCE VALUES ARE IN N(N)=NH.
ALL E. CAPACITORS ARE SHOWN IN THE FORM OF CAPACITANCE (μF)/RATED VOLTAGE (V).

*1		US/UB/UF
R7038	10K	
R7039	NI	

*2		58V/78V	98V
DB021, DB022	SELU1E50CM		TLYH156P
DB025	MTZJ10C-T2		
RB021, RB022	100	390	
DB031, DB032	SELU1E56BM		TLYH156P
DB035	MA3100/W-X		
RB031, RB032	430	560	

TO CD SECTION

⇒ CD signal

■ Tuner section

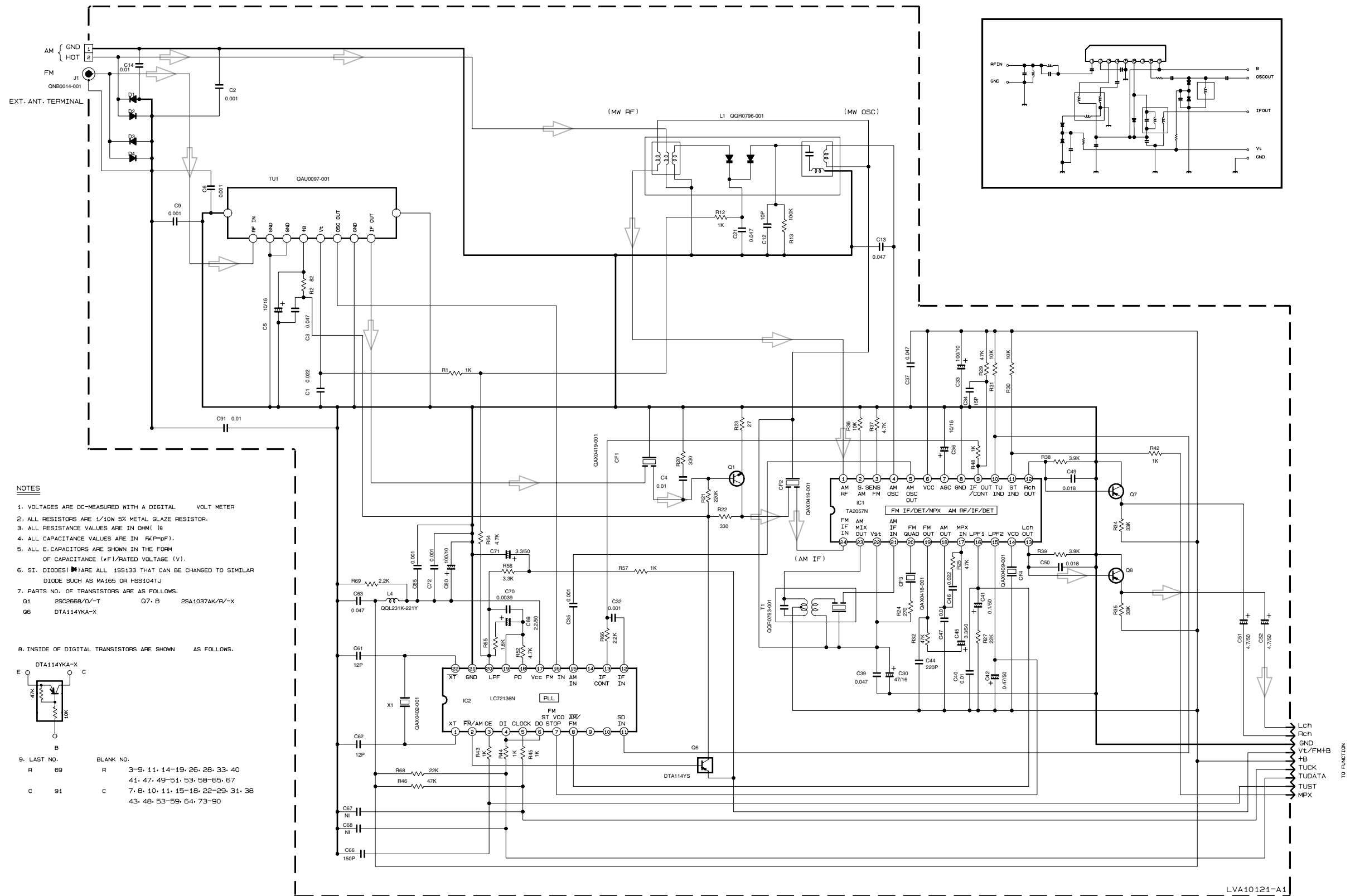

NOTES

1. VOLTAGES ARE DC-MEASURED WITH A DIGITAL VOLT METER
2. ALL RESISTORS ARE 1/10W 5% METAL GLAZE RESISTOR.
3. ALL RESISTANCE VALUES ARE IN OHM (Ω)
4. ALL CAPACITANCE VALUES ARE IN FEMTO (fF).
5. ALL E. CAPACITORS ARE SHOWN IN THE FORM OF CAPACITANCE (±F)/RATED VOLTAGE (V).
6. SI. DIODES (S) ARE ALL 1SS133 THAT CAN BE CHANGED TO SIMILAR DIODE SUCH AS MA165 OR HSS104TJ
7. PARTS NO. OF TRANSISTORS ARE AS FOLLOWS.
 Q1 2SC2668/O/-T Q7 B 2SA1037AK/R/-X
 Q6 DTA114YKA-X

8. INSIDE OF DIGITAL TRANSISTORS ARE SHOWN AS FOLLOWS.

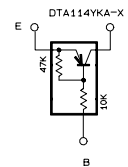

9. LAST NO. BLANK NO.

R	69	R	3-9, 11, 14-19, 26, 28, 33, 40
		C	41, 47, 49-51, 53, 58-65, 67
C	91	C	7, 8, 10, 11, 15-18, 22-29, 31, 38
			43, 48, 53-59, 64, 73-90

CONDITION	PIN NO.	1	2	3	4	5	6	7	8	9	10	11	12	13	14	15	16	17	18	19	20	21	22	23	24
IC1	FM NO SIGNAL	2.0	0.5	0	2.0	5.1	5.1	0	0	0.3	5.1	5.1	1.1	1.1	4.4	3.7	3.7	1.4	0	1.3	1.1	2.0	2.0	5.1	2.0
	FM 60dB STEREO	2.0	0.5	0	2.0	5.1	5.1	1.1	0	0.3	0	0	1.1	1.1	4.3	4.1	3.7	1.4	0	1.4	1.1	2.0	2.0	5.1	2.0
	AM NO SIGNAL	2.0	0.5	0	2.0	5.1	5.1	0	0	0.3	5.1	5.1	1.1	1.1	4.5	0.1	0	1.4	1.4	1.5	1.6	2.0	2.0	5.1	2.0
IC2	FM NO SIGNAL	2.4	0	0	1.1	5.0	1.1	3.7	3.7	0	0	5.1	0	0	0	0	2.6	5.1	1.0	1.0	3.7	0	2.7		

Tr. No.	Q1	Q6	Q7	Q8
PIN NAME	e c b e c b e c b e c b e c b	e c b e c b e c b e c b e c b	e c b e c b e c b e c b e c b	e c b e c b e c b e c b e c b
FM B7.5MHz	0 7 5 0 7 0 8 8 0 8 8 0 1 6 0 1 1 1 6 0 1 1 1	0 7 5 0 7 0 8 8 0 8 8 0 1 6 0 1 1 1 6 0 1 1 1	0 7 5 0 7 0 8 8 0 8 8 0 1 6 0 1 1 1 6 0 1 1 1	0 7 5 0 7 0 8 8 0 8 8 0 1 6 0 1 1 1 6 0 1 1 1
AM 520KHz	0 0	0 0	0 0	0 0

➡ Tuner signal

VCD section

5

4

3

2

1

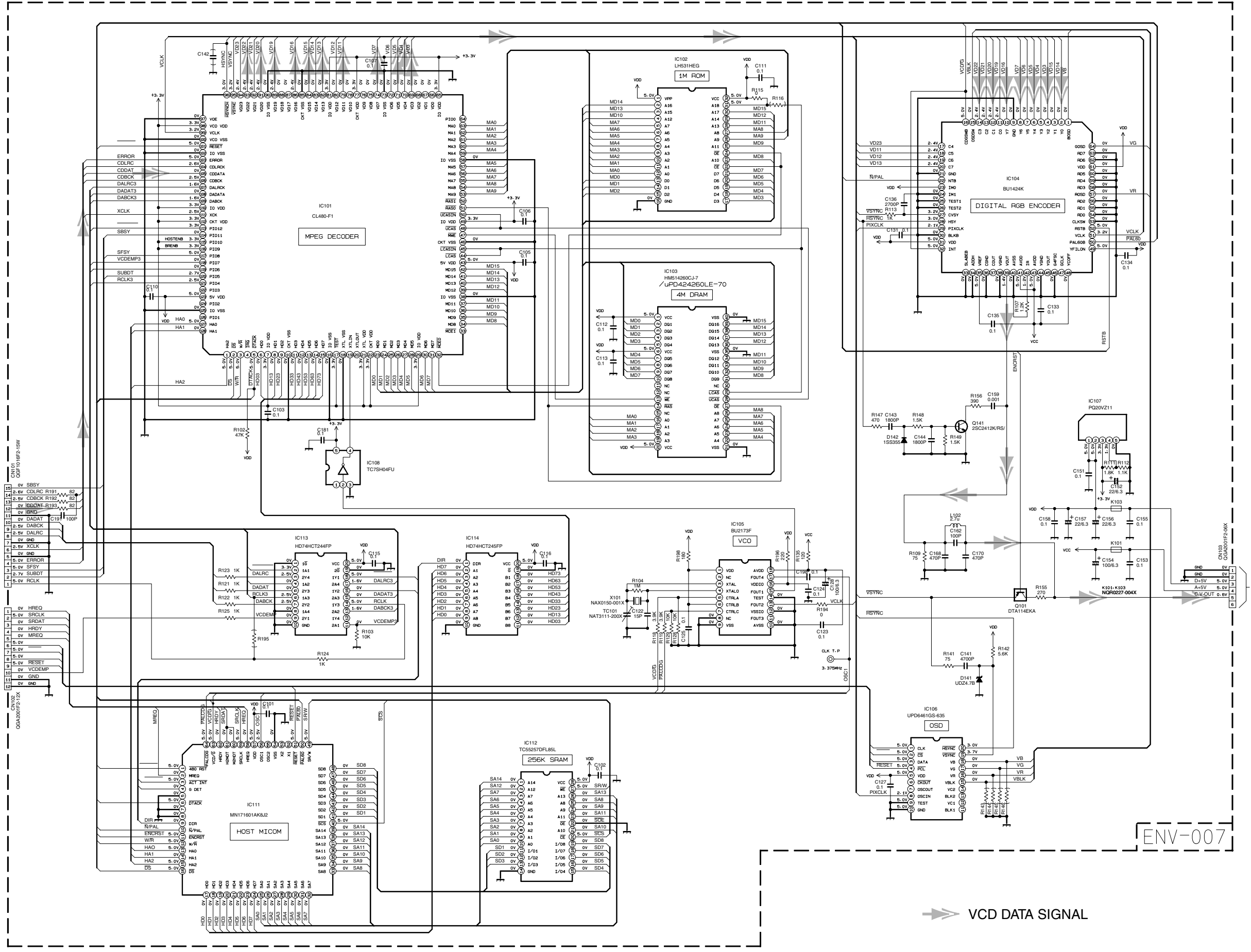

ENV-007

Note: d3/u/houki/s/ENV007.001
 UX-V50/FS-SD58V/78V/98V-VCD
 Note: s/RLVS20007-001A ENV-007

A B C 2-6 D E F G H

Printed circuit boards

5
4
3
2
1

■ Power IC board

■ Main board

■ LCD lamp board

■ Lamp board

■ Switch board

■ Speaker jack board

■ LCD board

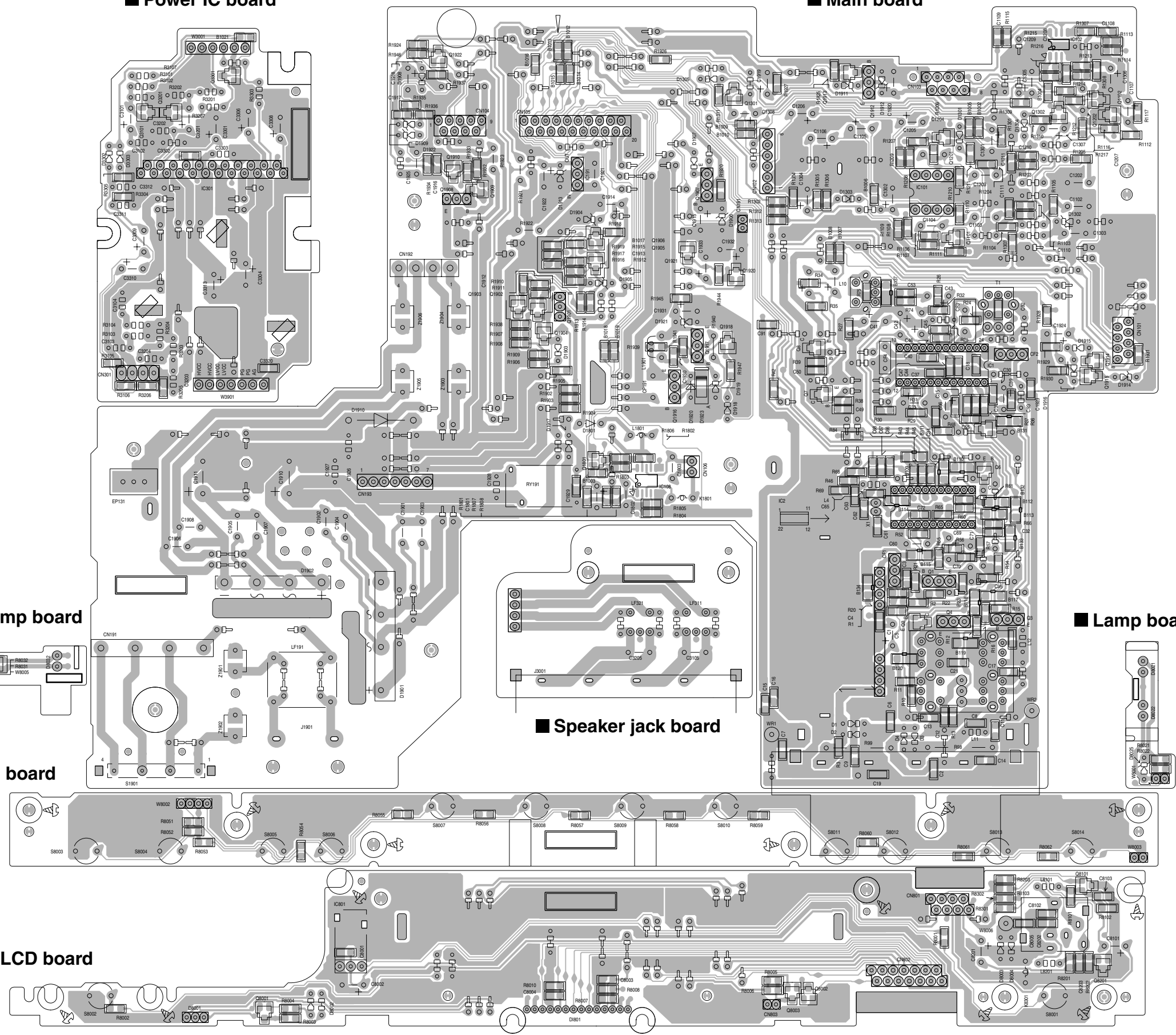

Note:10193.001a/ FS-SD58V/78V/98V

A B C D E F G

Line board(foward side)

Line board(reverse side)

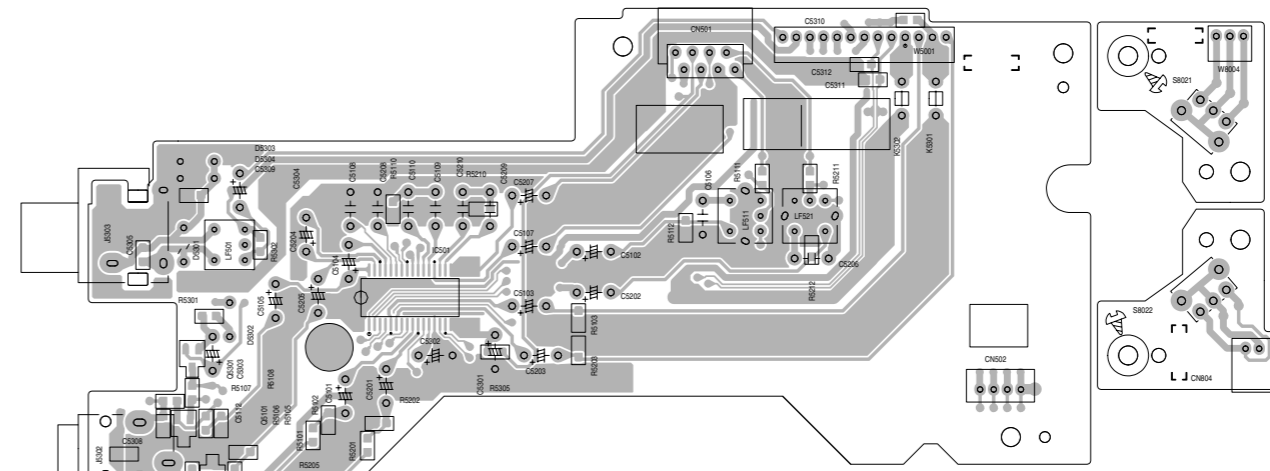
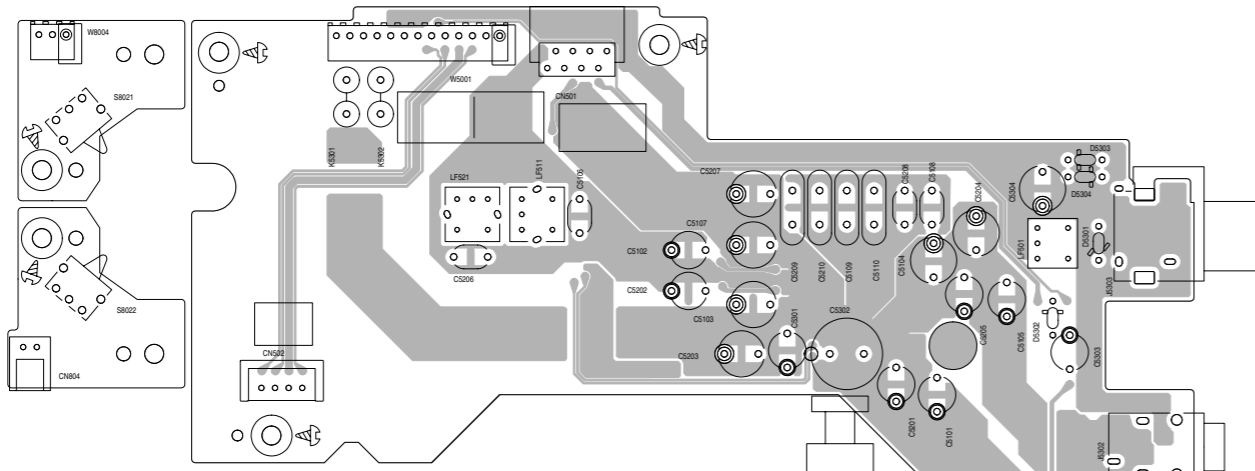

CD servo board(foward side)

CD servo board(reverse side)

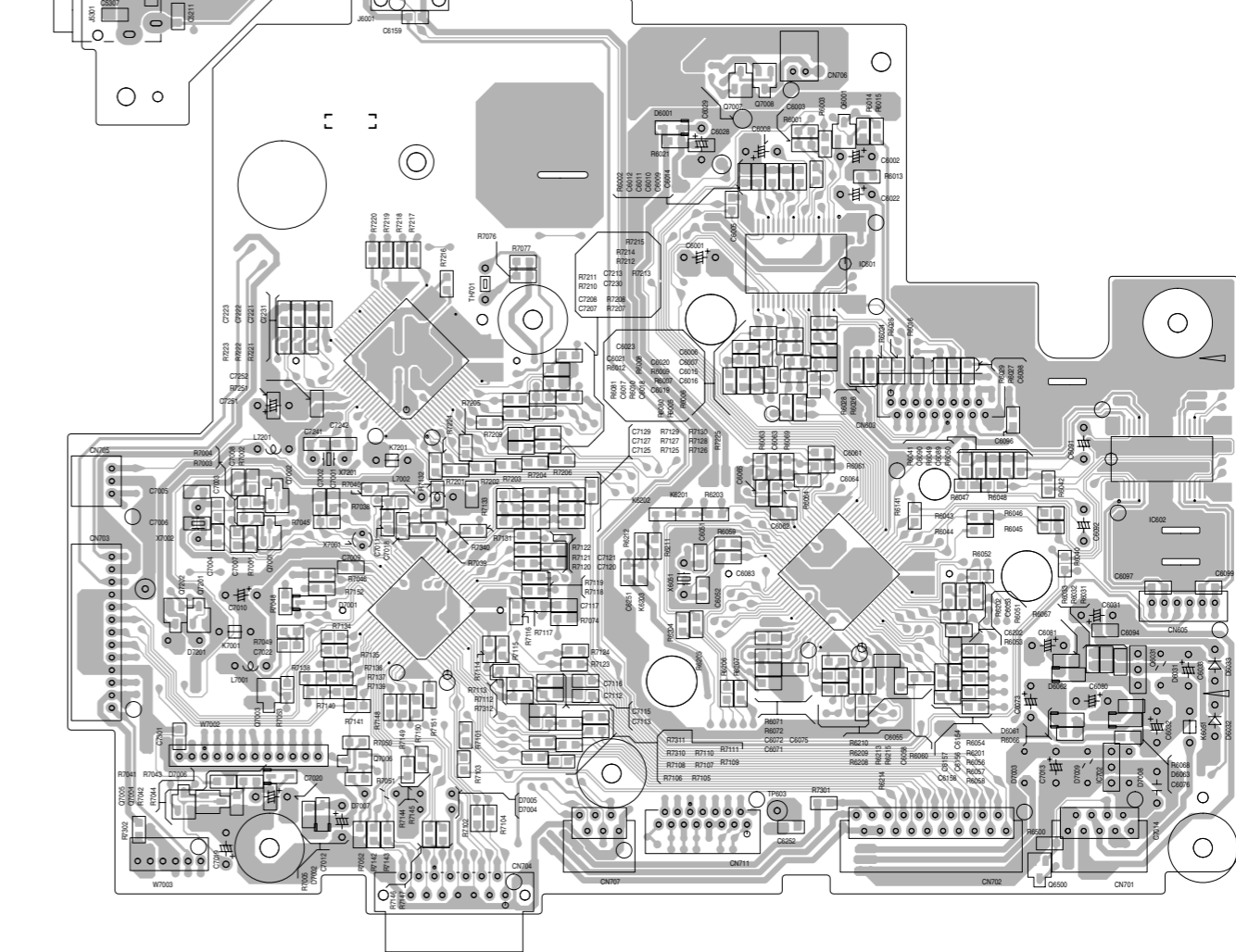
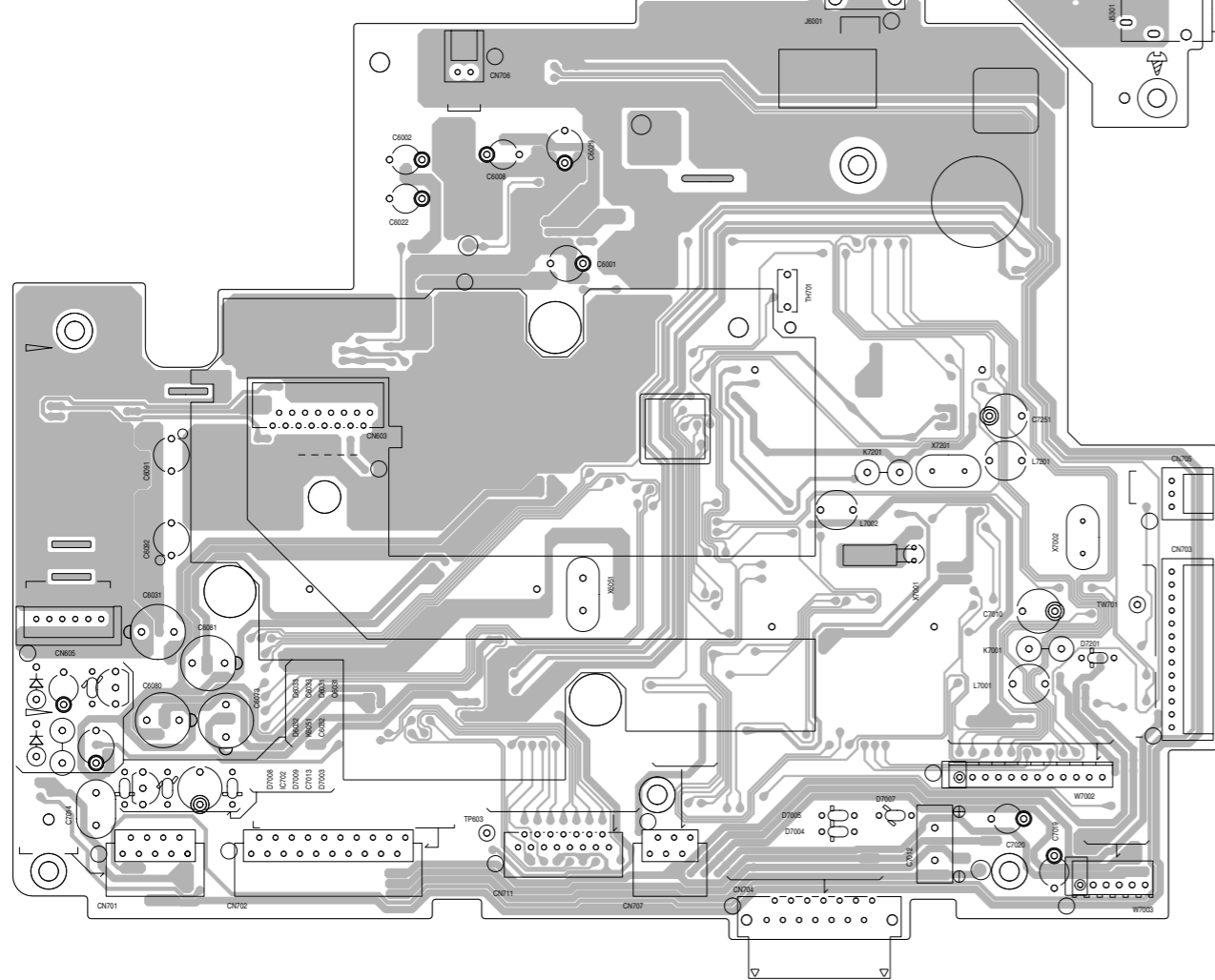

5
4
3
2
1

A B C 2-8 D E F G H

■ VCD board(reverse side)

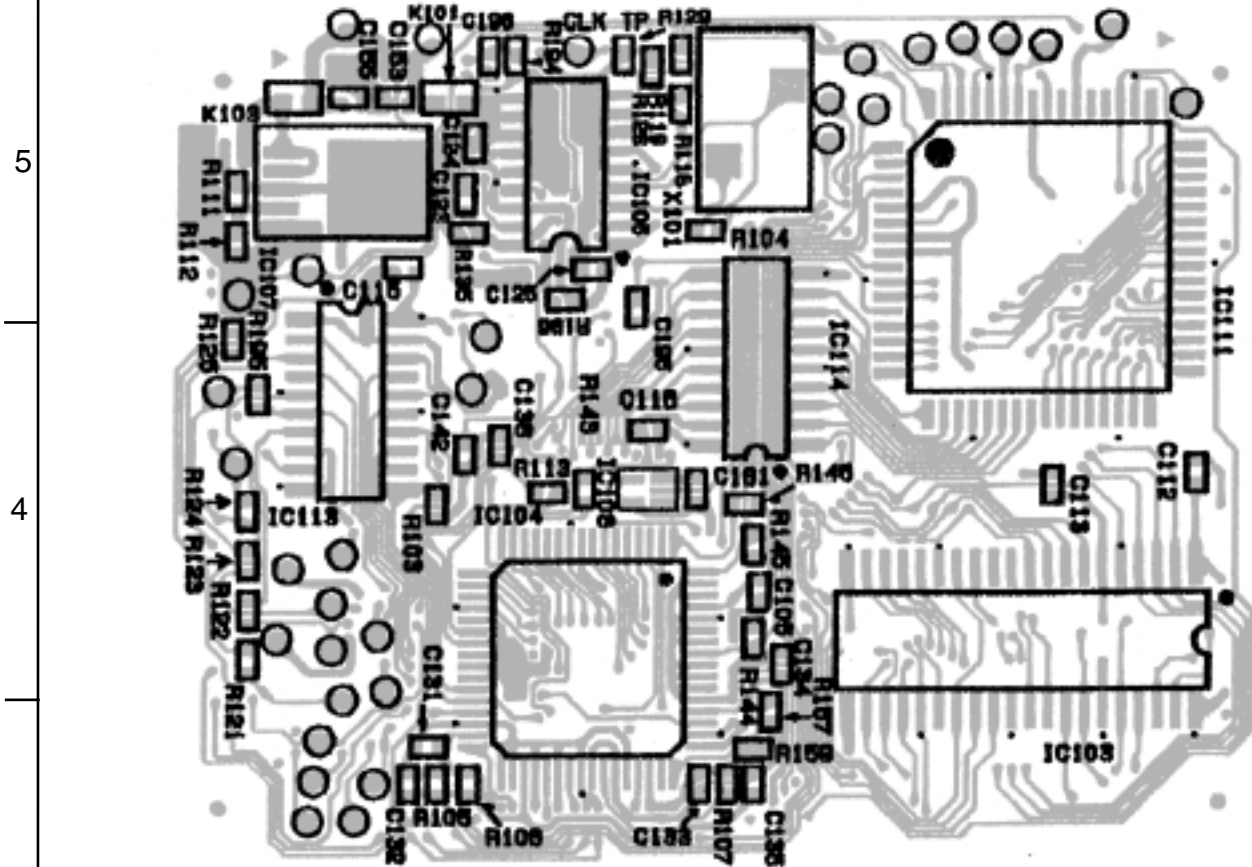

ENV-007 **A** EMN10727-201

■ VCD board(foward side)

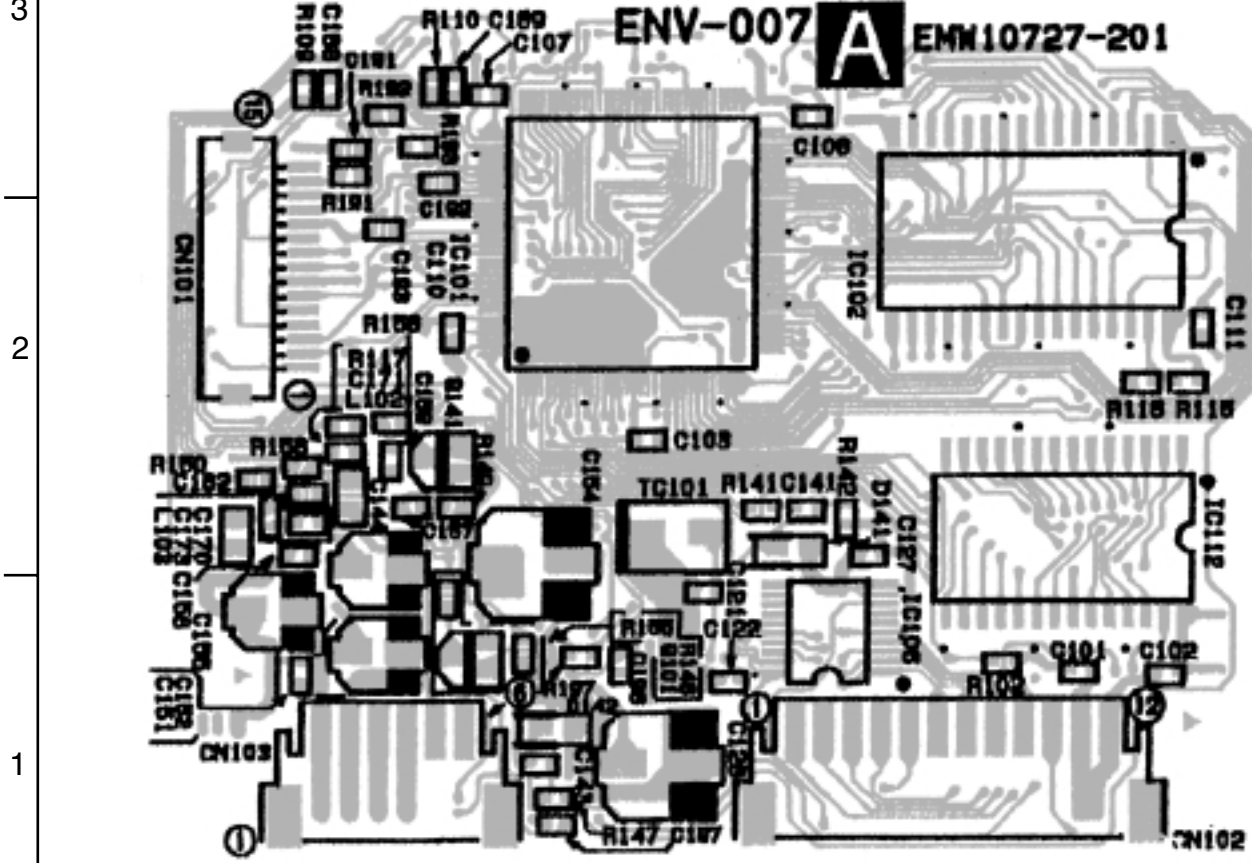

A

B

C

< MEMO >